

## Inverter welding machine SPARTUS® EasyTIG



**206P DC**



**User's manual**



## WELDING EQUIPMENT SUITABLE FOR TODAY'S NEEDS

### **Thank you for purchasing our product!**

You have made a right choice. Plasma welding and welding processes are carried out in difficult conditions that expose welding equipment to extreme tests of its strength. Only high quality equipment can ensure required reliability and performance during realization of the above-mentioned processes. SPARTUS® products are characterized by precisely such features: they are primarily reliable and durable, but they are also versatile. We listen carefully to clients' needs. Therefore, our offer covers such a wide assortment of products. Thank you very much for your trust in our company. We would like to invite you to familiarize yourself with the remaining products and offer at [www.spartus.info](http://www.spartus.info) or directly at a local distributor of SPARTUS® products.

# TABLE OF CONTENTS

<b>1.</b>	<b>SAFE USE – HAZARDS ASSOCIATED WITH ARC WELDING AND PLASMA CUTTING</b>	<b>2</b>
1.1	General safety rules	2
1.2	Electric shock can kill	2
1.3	Welding arc radiation can be dangerous	3
1.4	Vapours and gases can be dangerous	3
1.5	Noise can be harmful	4
1.6	Fire or explosion hazard	5
1.7	Other hazards	6
1.8	Other informations	6
1.9	Symbols used in instructions	7
<b>2.</b>	<b>ELECTROMAGNETIC FIELD (EMF)</b>	<b>7</b>
<b>3.</b>	<b>ELECTROMAGNETIC COMPATIBILITY (EMC)</b>	<b>7</b>
3.1	General informations	7
3.2	Assesment of area	8
3.3	Methods of reducing emmissions	8
<b>4.</b>	<b>CONFORMITY WITH STANDARDS</b>	<b>8</b>
4.1	CE marking	8
4.2	Rating plate	8
<b>5.</b>	<b>GENERAL DESCRIPTION</b>	<b>9</b>
5.1	Purpose of use	9
5.2	Purpose of use	9
<b>6.</b>	<b>TECHNICAL SPECIFICATIONS</b>	<b>10</b>
6.1	Operation, storage and transport	10
6.2	Technical parameters of device	10
<b>7.</b>	<b>INSTALLATION AND USE</b>	<b>11</b>
7.1	Proper cooling	12
7.2	Movement and handling	12
7.3	Description of construction	12
7.4	Connecting to power supply	13
7.5	Installation – TIG welding	13
7.6	Installation – MMA welding	14
7.7	Device control panel – using	15
<b>8.</b>	<b>MAINTENANCE</b>	<b>20</b>
<b>9.</b>	<b>ENVIRONMENTAL PROTECTION</b>	<b>21</b>
<b>10.</b>	<b>TROUBLESHOOTING</b>	<b>21</b>



## IMPORTANT!

*Before using this product, read the instruction manual in its entirety, with understanding. Keep the instructions for quick reference to it if necessary. Pay special attention to safety instructions provided for your protection. In the event of any points of misunderstanding instructions, contact your supplier or supervisor.*

# 1. SAFE USE – HAZARDS ASSOCIATED WITH ARC WELDING AND PLASMA CUTTING

Arc welding and plasma cutting are processes that can pose hazards for the operator and persons in his vicinity. The operator and his close surroundings are exposed, among others, to the risk of fire, explosion, electric shock, burning, as well as the risk of getting injured by moving parts of the device.

Once proper safety measures are provided, electric welding and plasma cutting are relatively safe processes. For this reason, it is crucial to strictly follow the valid OSH principles during welding operations.

The informations provided below do not release the operator from the obligation to follow the OSH rules that are binding in his plant/workplace.

## 1.1 GENERAL SAFETY RULES

Welding operators and persons working in the vicinity of the welding process should be made aware of the following hazards associated with arc welding. They should be made aware of protective measures as specified in relevant international and national standards and regulations.

### 1.1.1 Equipment condition and maintenance

- Check the technical condition of the device and accessories before starting to weld/plasma cutting. It is forbidden to use equipment that is unserviceable.
- Equipment damaged or defective should be immediately repaired or removed from service.

### 1.1.2 Operation and carrying

- Apply appropriate protective measures in the space around the zone, where welding operations are expected to be carried out.
- All equipment should be placed so that it does not present a hazard in passageways, on ladders or stairways, etc.
- Falling objects can cause injuries or kill. Protect device before accidentally falling.
- Welding equipment may be heavy (e.g. *wire*

*feeder fitted with spool and harness*). Care shall be taken during manual handling.

- To handle heavy elements, use hoists/trucks/transport equipment designed especially for this purpose. Make sure the weight of equipment to be handled does not exceed the admissible maximum lifting capacity of used hoist/truck/transport equipment.
- It is forbidden for unauthorized persons, especially children, to be in the vicinity of the device during its use.
- The device is not suitable for pipe defrosting.
- Device use non-compliant with its intended purpose is forbidden.

### 1.1.3 Training

- Only professionally trained and qualified personnel may install, operate, maintain and repair the device.
- For operators and their supervisors training is essential in: the safe use of the equipment; the processes; the emergency procedures.

## 1.2 ELECTRIC SHOCK CAN KILL



- Before starting to weld and during the welding process, the operator should insulate himself from the ground and the environment by means of dry and undamaged protective clothes. It is forbidden to work on wet ground.
- It is forbidden to touch SK sockets („+“ and/or „-“) when the device is in operation (*connected to a power supply source*).
- It is forbidden to touch live electric components of the device.

- Power supply must never be connected before the accessories of SK sockets/connectors are properly installed in the device.
- Use dry and undamaged welding gloves and protective clothing, in order to ensure proper insulation of the body. It is forbidden to touch with a bare hand any elements that are parts of an electric circuit.
- The operator must always make sure that there is a good electric connection of the return conductor to the element to be welded. The connection should be located as close to the welding zone as possible.
- Maintain the electrode grip, the welding torch, the chassis ground clamp, welding cables and the welding machine in proper technical condition that ensures safe operation. Damaged cable insulation should be replaced with new insulation.
- Never dip an electrode into water, to cool it down.
- When working above the floor level (at a height), use a safety harness to protect yourself against falling, in the case of potential electric shock.
- Exercise special caution, when using the device in small rooms or in rooms with elevated humidity levels.

### 1.3 WELDING ARC RADIATION CAN BE DANGEROUS



The arc generates:

- ultraviolet radiation (*can damage skin and eyes*);
- visible light (*can dazzle and impair vision*);
- infrared (*heat*) radiation (*can damage skin and eyes*).

Such radiation can be direct or reflected from surfaces such as bright metals and light coloured objects.

#### 1.3.1 Eye and face protection

- Use welder's helmet/shield with an appropriate filter to protect you face and eyes against sparks and welding arc radiation.
- The shield / helmet should provide eye and face protection against injuries that may result in welding spatters.
- Welding helmet/shield should be made in accordance with applicable standards.

#### 1.3.2 Body protection

- The body should be protected by suitable clothing in accordance with applicable standards.
- Use appropriate protective clothing made of durable and fire-resistant material, to ensure proper skin protection.
- The use of neck protection can be necessary against reflected radiation.

#### 1.3.3 Protection of persons in the vicinity of an arc

- Protect the remaining personnel present in the vicinity of welding works against negative impact of arc radiation and welding splatters. Warn them about the hazard resulting from exposure to the welding arc. In the vicinity of an arc, non-reflective curtains or screens should be used to isolate persons from the arc radiation. A warning, e.g. a symbol for eye protection, should refer to the hazard of arc optical radiation. Welder's assistants should also wear appropriate protective clothing.

### 1.4 VAPOURS AND GASES CAN BE DANGEROUS



Arc welding and allied processes produce welding fume which may pollute the atmosphere surrounding the work. Welding fume is a varying mixture of airborne gases and fine particles which, if inhaled or swallowed, constitute a health hazard.

The degree of risk is depend on:

- the composition of the fume;
- the concentration of the fume;
- the duration of exposure.

A systematic approach to the assessment of exposure is necessary, taking into account the particular circumstances of the operator and the ancillary worker who can be exposed.

Welding fume may be controlled by a wide range of measures, e.g. process modifications, engineering controls, methods of work, personal protection and administrative action.

First it is necessary to consider whether exposure can be prevented by eliminating the generation of welding fume altogether. Where this cannot be done, measures for reducing the quantity of welding fume generated should be investigated, after which the control of welding fume at source should be considered. The use of respiratory equipment should not be contemplated until all other possibilities have been eliminated. Normally, respiratory protective equipment should be used only as an interim measure. However, there cannot be a situation in which, in addition to ventilation, the use of personal protection is necessary.

### 1.4.1 VAPOURS AND GASES. ADDITIONAL PRECAUTIONS

- Welding operations can involve generation of vapours and gases that are hazardous to health. Inhaling the vapours should be avoided. Keep your head away from vapours during welding operations. Ensure proper ventilation and/or mechanical welding exhaust draught to keep vapours and gases away from the breathing zone.
- When welding is carried out in a confined space, operators should only be permitted to weld when other persons, who have been instructed and who are able to react

in case of an emergency, are in the immediate vicinity.

- In closed rooms or in certain circumstances during outdoor operations, it may be required to use individual equipment for the protection of the welder's airways, e.g. a respirator. Additional safety measures are also required when galvanized steel is welded.
- Welding operations must not be performed in the vicinity of chlorinated hydrocarbons generated during degreasing, cleaning or spraying. Heat and radiation generated by the arc may enter into a reaction with vapours of solvents, which may lead to the formation of phosgene – a highly toxic gas.
- The shielding gas used during arc welding may force the air out of a room. This may lead to a health hazard or even death. Proper ventilation, especially in closed rooms, should always be provided, to ensure appropriate amount of air that is indispensable for safe breathing.

## 1.5 NOISE CAN BE HARMFUL



In the welding environment, damaging levels of noise can exist. Continued exposure to a high noise level on the unprotected ear is injurious. The noise levels should be reduced to the lowest practicable level.

High levels may be tolerated for very short periods by wearing adequate ear protection in accordance with the national or local regulation. In case of doubt, checks by an expert should be made to establish noise levels in any particular environment, and, if these are in excess of the prescribed limit, one of the following alternatives may apply:

- a) insulation of the noise source as far as possible, e.g. by fitting silencers or sound proof enclosures,
- b) insulation of the operator from the noise

- source,
- c) effective maintenance of sound protection devices,
- d) indication as „ear protection areas“ where applicable,
- e) restriction of entry to these „ear protection areas“ to authorized persons,
- f) protect your hearing with appropriate personal protection measures, e.g. earplugs or hearing protectors.

## 1.6 FIRE OR EXPLOSION HAZARD

Arc welding and allied processes can cause fire and explosions. Precautions should be taken to prevent these hazards.

### 1.6.1 Fire hazard



- Before setting to perform welding operations, ensure that elements involving fire hazard are removed from the zone where welding operations will take place. If it is impossible, protect all flammable elements against the impact of sparks. Remember that sparks and hot metal may penetrate through small cracks and openings into the adjacent area.
- Avoid welding in the vicinity of hydraulic conduits.
- The welding arc throws sparks and splatters out. Welders should wear clean and dry protective clothing (*staining with oil should be avoided in particular*) such as welding gloves, welder's apron, welder's trousers, welder's boots, protective hood/cap, etc.
- When welding operations are not carried out, make sure that no part of the electrode comes into contact with the workpiece or protective earthing. Accidental contact may lead to overheating and create a fire hazard.
- The fire extinguisher should be ready for use and located in an easily accessible place.

- The surroundings of the work should be observed for an adequate period after its termination.
- „Hot spots“ and immediate surroundings should be observed until their temperature has dropped to normal.

### 1.6.2 Explosion hazard

It is forbidden to heat up, cut or weld tanks, barrels or containers that contained toxic or flammable materials. For there is an explosion hazard, even if the containers have been emptied and cleaned.

### 1.6.3 Use of cylinders with shielding gas

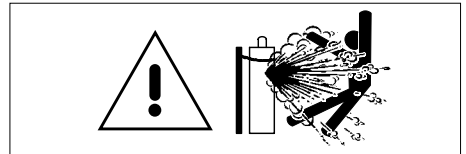

In case compressed gases are used in the work place, apply special safety measures to prevent dangerous situations.

- Use gas cylinders with appropriate shielding gas, foreseen for a particular process. Additional equipment (pressure regulator, hoses, connectors) should be in good technical condition. A gas cylinder and accessories should have the required valid attestations and approvals for use.
- Gas cylinders should always be stored in vertical position, fixed to an undercarriage or permanent support.
- Gas cylinders should be placed far away from areas, where they could be exposed to the risk of being overturned or suffering physical damage.
- Ensure gas cylinders are at a safe distance from places where electric welding or cutting operations are to be performed, away from other sources of heat, sparks or flames.
- Care shall be taken to prevent gas cylinders in the vicinity of the workpiece becoming part of the welding circuit.
- Never allow the electrode, electrode holder or any other live electric part to get in contact with the gas cylinder.

- Keep your face and head away from the cylinder valve socket when the valve is being opened.
- Special valve shield should always be installed during cylinder transportation or when the cylinder is not used.

## 1.7 OTHER HAZARDS

Arc welding and allied processes carrying other hazards not listed before.

### 1.7.1 Burns

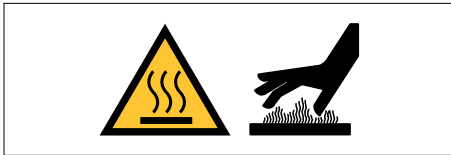

- Never touch hot parts with bare hands.
- Before handling an element, wait until it cools down.
- Use appropriate tools to grip and handle hot elements and wear special welding gloves and clothing that protects against burns.

### 1.7.2 Plasma arc is dangerous

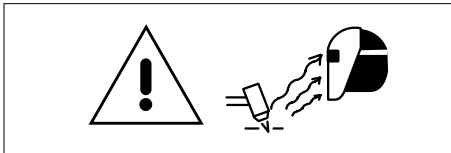

Highly concentrated plasma arc poses a hazard for health and life. It is forbidden to aim plasma arc at people.

### 1.7.3 Welding wire can cause injuries



Accidental pressing of the button on the welding torch can cause welding wire to advance in an uncontrolled manner. The welding wire tip may be sharp.

Never aim the burner tip of the welding torch at your face, eyes or other people.

### 1.7.4 Moving elements can be dangerous

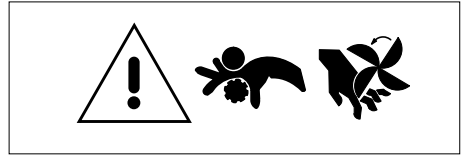

All protective elements and device housing should be in place and in good technical condition. Keep your hands, hair, clothes and tools away from gear wheels, fans and other moving parts during their operation.

Do not bring your hands close to fan motors. It is forbidden to stop a fan by pressing its axis.

### 1.7.5 HF – high frequency ignition may cause interference



As welding by the TIG method or plasma cutting involves high frequency ignition, it can interfere with mobile phones, radio equipment, TV equipment or improperly protected computers and industrial robots, which leads to total disabling of such devices.

## 1.8 OTHER INFORMATIONS

When performing welding work, you must apply equally to the health and safety requirements contained in the current normative acts, applicable in your country.



**WARNING!**

*The maximum voltage of 15kV. Accidental pressing of the microswitch results in unintentional arc ignition. Never bring a bare hand close to the electrode, when the device is connected to a power source.*

**1.9 SYMBOLS USED IN INSTRUCTIONS**

We use this symbol to pay your attention about important information.

**2. ELECTROMAGNETIC FIELDS (EMF)**

Electric current flowing through any conductor causes localized electric and magnetic fields (EMF). All welders should use the following procedures in order to minimize the risk associated with exposure to EMF from the welding circuit:

- Route the welding cables together – secure them with tape when possible.
- Place your torso and head as far away as possible from the welding circuit
- Never coil welding cables around your body.
- Do not place your body between welding cables. Keep both welding cables on the same side of your body.
- Connect the return cable to the workpiece as close as possible to the area being welded.
- It is forbidden to sit or lean on power source while working.
- Do not weld whilst carrying the welding power source or wire feeder.

**WARNING!**

*The electromagnetic field (EMF) generated during welding (and allied processes) may interfere with the operation of implanted medical devices for example: cardiac pacemakers. Persons with implanted medical devices such as cardiac pacemakers are obliged to consult a doctor before starting to weld/plasma cutting and to exercise special caution during work. It is forbidden for such persons to be present in the vicinity of the place where welding/plasma cutting processes are realized without previous consultation of a doctor.*

**3. ELECTROMAGNETIC COMPATIBILITY (EMC)****WARNING!**

*This Class A equipment is not intended for use in residential locations where the electrical power is provided by the public low-voltage supply system. There can be potential difficulties in ensuring electromagnetic compatibility in those locations due to conducted as well radiated radio-frequency disturbances.*

**3.1 GENERAL INFORMATIONS**

The user is responsible for installing and using the arc welding equipment according to the manufacturer's instructions. If electromagnetic disturbances are detected, then it shall be the responsibility of the user of the arc welding equipment to resolve the situation with the technical assistance of the manufacturer. In some cases this remedial action may be as simple as earthing the welding circuit. In other cases, it could involve constructing an electromagnetic screen enclosing the welding power source and the work complete with associated input filters. In all cases electromagnetic disturbances shall be reduced to the point where they are no longer troublesome.

! *Welding and plasma cutting processes may emit additional interferences. User is responsibility for the interferences caused by welding and plasma cutting.*

### 3.2 ASSESSMENT OF AREA

Before installing arc welding equipment, the user shall make an assessment of potential electromagnetic interferences in the surrounding area. The following shall be taken into account:

- a) other supply cables, control cables, signaling and telephone cables, above, below and adjacent to the arc welding equipment,
- b) radio and television transmitters and receivers,
- c) computer and other control equipment,
- d) safety critical equipment, for example guarding of industrial equipment,
- e) the health of the people around, for example the use of pacemakers and hearing aids,
- f) equipment used for calibration or measurement,
- g) the immunity of other equipment in the environment. The user shall ensure that other equipment being used in the environment is compatible. This may require additional protection measures.
- h) the time of day that welding or other activities are to be carried out.

The size of the surrounding area to be considered will depend on the structure of the building and other activities that are taking place. The surrounding area may extend beyond the boundaries of the premises.

### 3.3 METHODS OF REDUCING EMISSIONS

Methods of reducing electromagnetic interference are listed in detail in the standard EN 60974-9 – „Arc welding equipment – Part 9: Installation and use“.

## 4. CONFORMITY WITH STANDARDS

SPARTUS® EasyTIG 206P DC is in conformity with the relevant Union harmonization legislation:

<b>LVD 2014/35/UE</b>	<b>Low Voltage Directive</b>
<b>EMC 2014/30/UE</b>	<b>Electromagnetic Compatibility Directive</b>

harmonized standards:

<b>EN 60974-1</b>	<b>Arc Welding Equipment – Part 1: Welding Power Sources</b>
<b>EN 60974-10</b>	<b>Arc Welding Equipment – Part 10: Electromagnetic Compatibility Requirements</b>

### 4.1 CE MARKING

CE marking is placed on the nameplate of device and/or on the front panel of device.



### 4.2 RATING PLATE

Rating plate and serial number are located on the device case.

## 5. GENERAL DESCRIPTION

### SPARTUS® EasyTIG 206P DC

Modern digitally controlled inverter welding machines, constructed on the basis of IGBTs and PWM technology. Allows welding TIG and MMA with current up to 200A. They are powered with single-phase 230V source power.

Small, light and versatile, ideal for welding stainless and acid-resistant steels. Built-in pulse welding mode allows you to weld very thin elements. We achieve excellent weld quality at high welding speed, while minimizing the heat input into the material, thanks to the included COLD WELD function in the machine.

Easy-to-use and intuitive function panel allows you to precise control of all most important welding parameters for TIG DC and MMA DC modes.

EasyTIG 206P DC allows you to set the following parameters in the TIG method:

- upslope/downslope time,
- for TIG Puls: puls current, base current, pulse frequency, pulse width,
- mode selection 2T/4T,
- pre gas, post gas,
- COLD WELD,

while the MMA method is supported by functions:

- VRD,
- Arc Force,
- Hot Start.

The device is equipped with wide range of modern technologies which support operator during welding or secures device before damage.

Examples of use: portable repair, workshop, maintenance, light constructions.

### 5.1 PURPOSE OF USE

SPARTUS® EasyTIG 206P DC:

- Tungsten Inert Gas welding (TIG)
- Manual Metal Arc welding (MMA) (SMAW – Shielded Metal Arc Welding).

## 6. TECHNICAL SPECIFICATIONS

### 6.1 OPERATION, STORAGE AND TRANSPORT

#### Conditions during operation, storage and transport

Range of ambient air temperature during operation	-10°C to +40°C
Relative humidity of the air	up to 50% at +40°C up to 90% at +20°C
Ambient air	free from abnormal amounts of dust, acids, corrosive substances etc. other than those generated by the welding process
Base of the welding power source inclined	up to 10°
Range of ambient air temperature during storage and transport	-20°C to +55°C

**Duty cycle (def.)**

Duty cycle is the time during which You can weld or cut at a certain load without causing overload. It is expressed in percent for period of complete cycle which equals 10 minutes. For example: 60% duty cycle means that for 6 minutes device can operate at given load, after that required 4 minutes time break (no-load operation).

**Protection against overheating (def.)**

Security system from overheating will turn on when the welder is over-heat (possibility of welding is turned off, abnormal indicator on front panel lights up). In such a situation, You should not turning off the unit immediately. Wait some time until fan cools the unit. Time to return to the state from overheating can take up to approx. 15 minutes.



The device has a degree of protection IP21S. Which means that it is intended to be used in closed and covered areas and suitable for use outdoors. However it is not designed to be used outdoor during precipitation if it is not covered.

**6.2 TECHNICAL PARAMETERS OF DEVICE****EasyTIG 206P DC**

Input	~1 x 230V ±10% 50/60 Hz
Welding current TIG [A]	10 – 200
Duty cycle [%]	35

**TIG PARAMETERS**

Start Amps, End Amps	✓
Gas pre flow [s]	0 – 1
Up slope [s]	0 – 5
Down slope [s]	0 – 5
Gas post flow [s]	0.1 – 10
TIG PULSE mode	✓
Pulse Width [%]	5 – 100
Pulse frequency [Hz]	0.5 – 100
2T/4T control	✓
Arc ignition	LIFT / HF*
COLD WELD	✓

**MMA PARAMETERS**

Coated electrode MMA welding	✓
Welding current MMA [A]	10 – 200
Duty cycle MMA [%]	35
Arc Force range [%]	0 – 10
Hot Start range [%]	0 – 10
No-load voltage [V]	64
VRD	✓

## OTHER

Current consumpton [A]	TIG 34 / MMA 50
Power factor (cosφ)	0.69
Efficiency η [%]	TIG 78.3 / MMA 82
Insulation class	H
Protection class	IP21S
Weight [kg]	6.5
Dimensions [mm]	410 x 145 x 245

\* **LIFT** – the arc ignition by rubbing the electrode on the workpiece.

**HF** – contactless arc ignition.

## 7. INSTALLATION AND USE



### WARNING!

*SPARTUS® EasyTIG machines are intended for professional and industrial applications. Installation and use of the device may only be carried out appropriately trained professionals.*

*It is **forbidden** to grinding and/or carrying out other locksmith works or mechanical working of metal in the vicinity of the ventilation opening of unit.*



### Qualified person (def.)

*A person who has gained the relevant technical education, training took place and / or gained experience to perceive the risk and avoid hazards during use of the product (IEC 60204-1).*

### 7.1 PROPER COOLING

The unit should be placed stable on a dry and flat surface. Avoid too much slope and slippery surfaces. Check regularly that the vents (inlet, outlet) are not covered. The minimum distance between the welder vents and walls should be 50cm.

### 7.2 MOVEMENT AND HANDLING

When moving the welding machine please take extra care. The device should be moved by using specially designed transport lugs. If transport handle is damaged, then it needs to be repaired at an authorized service center.

### 7.3 DESCRIPTION OF CONSTRUCTION

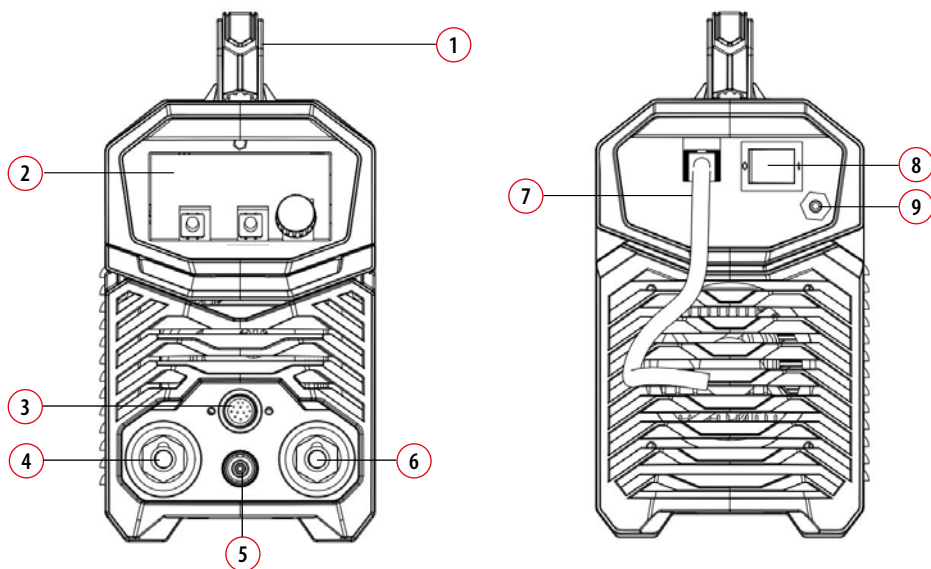

- |   |                                      |   |                        |
|---|--------------------------------------|---|------------------------|
| ① | Transport handle                     | ⑥ | SK socket „-“          |
| ② | Control panel                        | ⑦ | Power cable            |
| ③ | Socket: TIG torch control plug       | ⑧ | Toggle switch ON/OFF   |
| ④ | SK socket „+“                        | ⑨ | Shield gas input joint |
| ⑤ | Shield gas connector – for TIG torch |   |                        |

### 7.4 CONNECTING TO POWER SUPPLY

Requirements for power network parameters (voltage, permissible range of mains voltage fluctuations etc.) are given in the table with technical parameters of device and on the rating plate of welding machine.

#### Before connecting the unit to the power source:

- Check whether the parameters comply with the requirements for unit.
- Check: mechanical condition of the power cord and plug. The connection status of the power cord with plug and unit (loose not allowed). If the power cord or plug is damaged or loose connection is between them, it is forbidden to connect the welder until fault has been rectified.
- The welder machine can be connected to the network only when the power socket is properly grounded.

## 7.5 INSTALLATION – TIG WELDING



Before connecting hardware and shielding gas to the device, make sure that the device is disconnected from power source and switch **8** is in the OFF position.

### 7.5.1 Connecting the gas cylinder

1. The cylinder with appropriate shielding gas (*in TIG welding is an inert gas, frequently argon, helium or a mixture of both*), should stand upright and be secured against tipping over in accordance with safety requirements.
2. Make sure that the valve cylinder is closed.
3. Connect properly gas regulator to cylinder valve.
4. Connect the gas hose into gas regulator outlet. Use special clamps to seal connection.
5. Connect gas hose to the device **9**.



The valve in the cylinder must be opened immediately before welding.  
After welding it should be closed.

### 7.5.2 TIG torch installation

1. Connect properly TIG torch plug into SK „-“ **6**.
2. Connect properly TIG torch control plug into control socket **3**.  
Pay attention to suitable fitting of control pins.
3. Connect gas hose into shield gas connector at the front panel **5**.

### 7.5.3 Connecting the device

1. Connect gas hose into device (*see 7.5.1*).
2. Connect TIG torch into device (*see 7.5.2*).
3. Connect the return line to the SK socket „+“ **4**, and the earth clamp into workpiece.
4. Connect the welding device to the power source in accordance with the guidelines (*see 7.4*)
5. Turn on the device by setting power switch **8** in the ON position.
6. The device is ready to work.

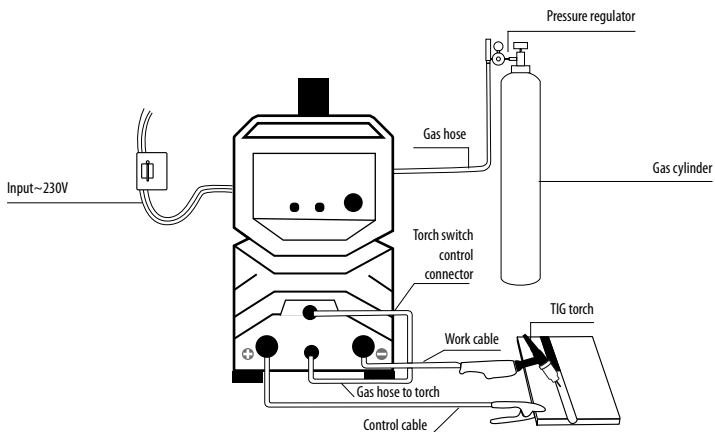

## 7.6 INSTALLATION – MMA WELDING



Before connecting hardware and shielding gas to the device, make sure that the device is disconnected from power source and switch **8** is in the OFF position.



The welding polarity depends on the type of electrodes used. Before connecting the cables refer to the requirements specified by the manufacturer of electrodes.

1. Connect electrode cable plug into SK socket **4** or **6**.
2. Connect return cable plug into appropriate SK socket **4** or **6**.
3. Connect earth clamp into workpiece.
4. Connect the welder into power supply in accordance with appropriate guidelines (see 7.4).
5. Turn on the welder by setting power switch **8** to the ON position.
6. The device is ready to weld.

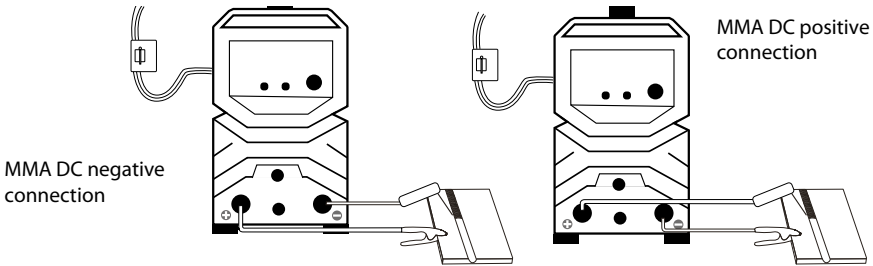

## 7.7 DEVICE CONTROL PANEL – USING

### 7.7.1 Function panel description

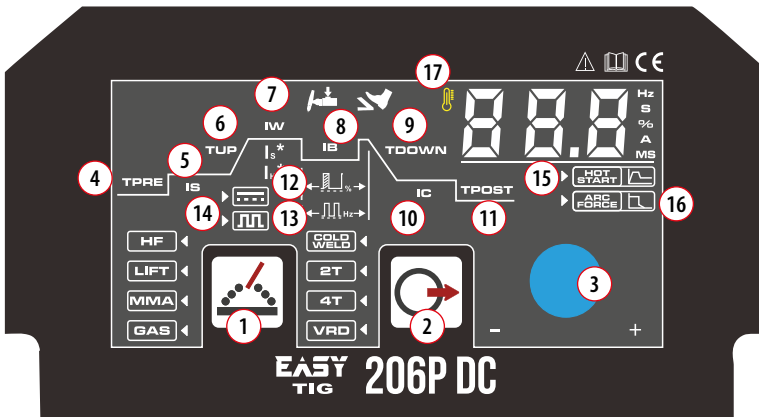



- |   |   |
|---|---|
| <ul style="list-style-type: none"> <li>① Function selection button: HF TIG, LIFT TIG, MMA, GAS</li> <li>② Mode selection button: COLD WELD, 2T, 4T, VRD</li> <li>③ Parameter adjust knob</li> <li>④ Pre-gas</li> <li>⑤ Start current</li> <li>⑥ Up slope time</li> <li>⑦ Welding current</li> <li>⑧ Base current</li> </ul> | <ul style="list-style-type: none"> <li>⑨ Down slope time</li> <li>⑩ Crater current</li> <li>⑪ Post-gas</li> <li>⑫ Balance</li> <li>⑬ Frequency</li> <li>⑭ Pulse</li> <li>⑮ Hot Start</li> <li>⑯ Arc Force</li> <li>⑰ Voltage abnormality</li> </ul> |
|---|---|

**TIG LIFT/TIG HF parameter selection button:**

SYMBOL	NAME	PARAMETER
TPRE	Pre flow time	0-1s
IS	Start current	10-200A
TUP	Up slope	0-5s
IW	Peak current	10-200A
IB	Base current	10A
TDOWN	Down slope	0-5s
IC	Crater current	10-200A
TPOST	Post flow time	0.1-10s
%	Pulse frequency	5-100%
Hz	Pulse frequency	0.5-100Hz

**COLD WELD parameter selection button:**

SYMBOL	NAME	PARAMETER
TPRE	Pre flow time	0-1s
IW	Peak current	10-200A
lhZ	COLD WELD parameter	0-10Hz
Is	COLD WELD time	1-200ms
TPOST	Post flow time	0.1-10s

**MMA parameter selection button:**

SYMBOL	PARAMETER
HOT START	0-10%
ARC FORCE	0-10%

*When the „Adjust knob“ is adjusted to the corresponding function, the indicator light will turn on. When you need to select the function setting parameters, press the „Adjust knob“ and the indicator light will blink. At this time, you have entered the function selection state, and you can twist the knob to select the function. After select a function, press the „Adjust knob“ again to enter the parameter adjustment state of the function. You can adjust the parameters by twisting the knob.*

### 7.7.5 Course of TIG welding process – 2T

During TIG function 2T, you can not set the current parameters of the initial and final current.

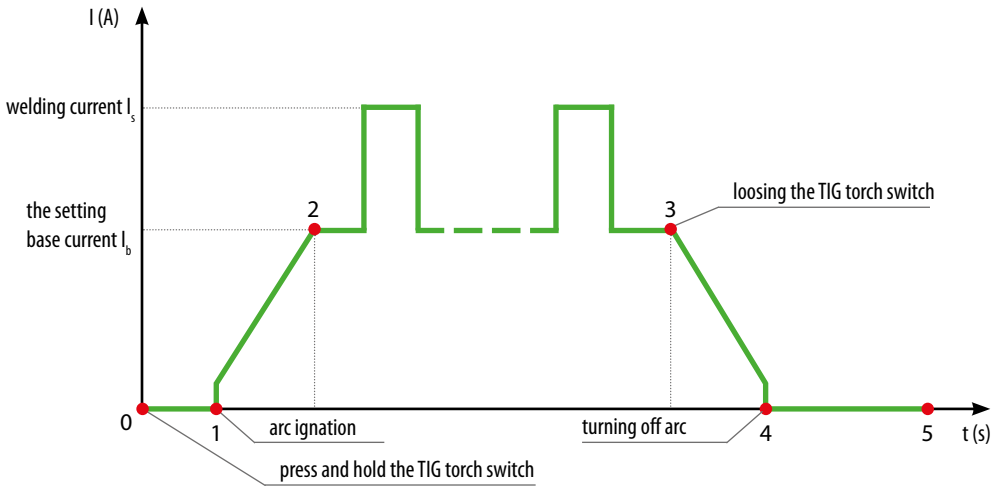

- 0 Press the gun switch and hold it. Electromagnetic gas valve is turned on. The shielding gas starts to flow.
- 0-1 Pre-gas time.
  - 1 Initiation of the welding arc.
- 1-2 Arc is ignited and the output current rises to the setting welding current from the min. welding current.
- 2-3 During the whole welding process, the gun switch is pressed and held without releasing.
- 3 Release the gun switch, the welding current will drop in accordance with the selected down-slope time.
- 3-4 The current drops to the minimum welding current from the setting current, and then arc is turned off.
- 4 Termination arc welding.
- 4-5 Post-gas time, after the arc is turned off. You can adjust it (0.1~10s) through turning the knob on the front panel.
- 5 Electromagnetic valve is closed and stop argon flowing. Welding is finished.

### 7.7.6 Course of TIG welding process (4T)

During TIG 4T, it is possible to preset the current value of the initial and final current. With this feature, you can prevent flooding at the beginning of the weld and fill the crater formed at the end of the weld.

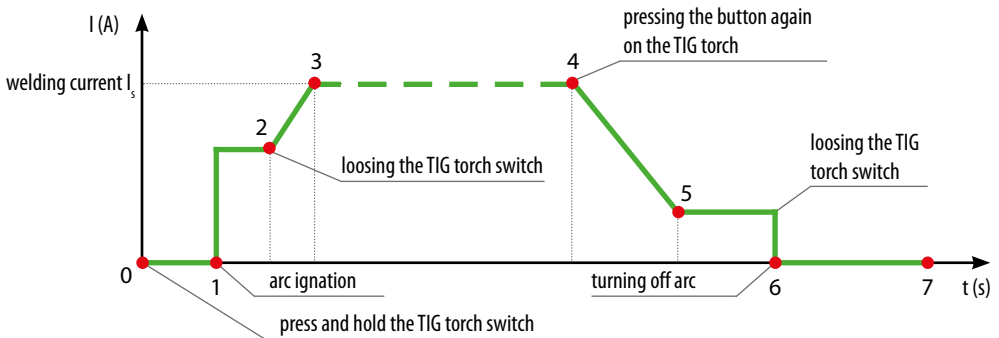

- 0 Press and hold the gun switch, Electromagnetic gas valve is turned on. The shielding gas starts to flow.
- 0-1 Pre-gas time.
- 1-2 Arc is ignited at  $t_1$  and then output the setting value of start current.
- 2 Loosen the gun switch, the output current slopes up from the start current.
- 2-3 The output current rises to the setting value, the upslope time can be adjusted.
- 3-4 Welding process. During this period, the gun switch is loosen.
- 4 Press the torch switch again, the welding current will drop in accordance with the selected down-slope time.
- 4-5 The output current slopes down to the crater current. The downslope time can be adjusted.
- 5-6 The crater current time.
- 6 Loosen the gun switch, stop arc and keep on argon flowing.
- 6-7 Post-gas time.
- 7 Electromagnetic valve is closed and stop argon flowing. Welding is finished.

## 8. MAINTENANCE

### **WARNING!**

Before performing any maintenance or repairing of device, disconnect welding machine from the power source and wait at least 5 minutes. The voltage accumulated in capacitors should be discharged at this time to a safe level. But even after that operation you should be careful.



Make sure that the device is disconnected from the power source, and switch **8** is in the OFF position, before connecting accessories and shielding gas to the device.

Maintenance and repair work may be performed only by qualified personnel with the appropriate permissions. Regular maintenance provides adequate service life and trouble-free operation of the device.

### **Routine maintenance (daily: before use/installation):**

- Perform a visual inspection of the housing, knobs, control panel.
- Inspect (visual inspection) the power cord and power plug. Check the insulation of the cable.
- Check the condition of welding cables and their connectors. If cable insulation is damaged – replace it. If connection is too loose – eliminate backlash.
- Check if cooling fan is working properly.
- Make sure that all vents are not obstructed.

### **At least once a month:**

- Regularly remove dust from inside of the machine. Use for this compressed air. The pressure should be sufficiently low so as not to damage small components inside the machine. If in the workplace, dust levels are high. You should clean machine often.
- Perform inspection of connection of internal electrical components. If anywhere the joints are loose, tighten them.

## 9. ENVIRONMENTAL PROTECTION

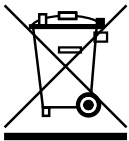

The product must not be disposed of into an ordinary waste container. It is totally forbidden to dispose of electric or electronic equipment marked with a crossed-out trash can symbol by throwing it into ordinary waste containers. According to the WEEE directive (directive 2012/19/UE), binding within the European Union, such products should be disposed of according to local regulations.

We hereby inform the client that, according to the regulations, each commodity is burdened with waste disposal costs (WDC) according to charging rates valid for a given year.

**Attention!** If using liquid to water-cooled torches, utilize it according to attached information.

## 10. TROUBLESHOOTING



Not all problems with functioning of the device, are the evidence of failure. You can independently carry out an analysis in search of probable failure. In case of doubt, please contact to SPARTUS® dealer or authorized service center.



During the warranty period all repairs should be carried by authorized service center. Repairs carried out by unauthorized persons will void the warranty.

### PROBLEM WITH TURNING ON THE MACHINE

	Incorrectly connected power. Switching on voltage control system.
After turning on the unit the fan is not working, digital meter is working. The unit does not weld.	Unstable supply voltage. Too thin power cords or incorrectly connected power cables.
	Incorrectly turned on power switch. Switching on control system overvoltage.
	Failure of power switch.
After turning ON the switch the device does not correspond	Poorly connected to the supply voltage.
	Failure of power switch

### TIG WELDING PROBLEMS

The problem with TIG arc ignition (HF and no HF). There is a spark when HF works.	Poorly connected TIG torch. Return cable poorly connected or not connected.
	Damaged current cable of TIG torch.
The problem with TIG arc ignition (HF and no HF). There is no spark when HF works.	Damaged microswitch.
	Control plug is not connected. Problems with control plug.
No gas flow	Closed valve in the gas cylinder, a closed valve in the gas pressure regulator. Clogged gas hoses leading the gas to the device.
	Electromagnetic valve is damaged.
After switching on the device gas flows all the time.	Electromagnetic valve is damaged.
The problem of obtaining adequate weld penetration	Too low welding current.
	Improper welding parameters
Poor quality of weld	Too little flow of the shielding gas or its quality is inadequate.
	Excessively worn of tungsten electrode

**MMA WELDING PROBLEMS**

Arc ignition problem.	Incorrect connection of return cable or there is no connection of return cable.
	Too low welding current.
Excessive spatter welding. The problem with the arc ignition.	Incorrect welding polarity.
Unstable arc, excessive spatter welding, poor weld quality – MMA.	Incorrect welding polarity.
	Electrode is damp or incorrectly heated
	Unstable voltage in
No load voltage equals 0V	Damaged device

**OTHERS**

The warning light came on. The overheating protection was switched on.	Too much welding current. Exceeded operation cycle.
	Voltage too high in the mains.
The warning light on the functional front panel came on	Too much power voltage drop
	Too many devices connected at one time to the network.



**EASY**

*Simple solutions and an attractive price – these are the features of SPARTUS® Easy series devices. Our equipment has been designed with ease of use and ergonomics at work in mind.*

*A masterly combination of high quality production, excellent parameters and ergonomics – these are features of the SPARTUS® Master series of devices, which were created with demanding welding jobs in mind.*



**MASTER**



**PRO**

*Precision, functionality, excellent parameters and resistance to high workloads – these are the features of the SPARTUS® Pro industrial series of devices. This series consists of specialised solutions which will satisfy even the most demanding users.*



Videopresentation of products



Subscribe to the channel [SPARTUS.INFO](https://www.youtube.com/channel/UC...)