

Semiautomatic welder SPARTUS® EasyMIG



317DP



WELDING EQUIPMENT SUITABLE FOR TODAY'S NEEDS

Thank you for purchasing our product!

You have made a right choice. Plasma welding and welding processes are carried out in difficult conditions that expose welding equipment to extreme tests of its strength. Only high quality equipment can ensure required reliability and performance during realization of the above-mentioned processes. SPARTUS® products are characterized by precisely such features: they are primarily reliable and durable, but they are also versatile. We listen carefully to clients' needs. Therefore, our offer covers such a wide assortment of products. Thank you very much for your trust in our company. We would like to invite you to familiarize yourself with the remaining products and offer at www.spartus.info or directly at a local distributor of SPARTUS® products.

TABLE OF CONTENTS

1. SAFE USE – HAZARDS ASSOCIATED WITH ARC WELDING AND PLASMA CUTTING	2
1.1 General safety rules	2
1.2 Electric shock can kill	2
1.3 Welding arc radiation can be dangerous	3
1.4 Vapours and gases can be dangerous	3
1.5 Noise can be harmful	4
1.6 Fire or explosion hazard	5
1.7 Other hazards	6
1.8 Other informations	6
1.9 Symbols used in instructions	7
2. ELECTROMAGNETIC FIELD (EMF)	7
3. ELECTROMAGNETIC COMPATIBILITY (EMC)	7
3.1 General informations	7
3.2 Assessment of area	8
3.3 Methods of reducing emmissions	8
4. CONFORMITY WITH STANDARDS	8
4.1 CE marking	8
4.2 Rating plate	8
5. GENERAL DESCRIPTION	8
5.1 Purpose of use	9
6. TECHNICAL SPECIFICATIONS	9
6.1 Operation, storage and transport	9
6.2 Technical parameters of device	10
7. INSTALLATION AND USE	11
7.1 Proper cooling	11
7.2 Movement and handling	11
7.3 Description of construction	12
7.4 Connecting to power supply	13
7.5 Installation – MIG/MAG welding	13
7.6 Installation – MMA welding	16
7.7 Installation – TIG welding	17
7.8 Device control panel – using	18
8. MAINTENANCE	23
9. ENVIRONMENTAL PROTECTION	23
10. TROUBLESHOOTING	23



IMPORTANT!

Before using this product, read the instruction manual in its entirety, with understanding. Keep the instructions for quick reference to it if necessary. Pay special attention to safety instructions provided for your protection. In the event of any points of misunderstanding instructions, contact your supplier or supervisor.

1. SAFE USE – HAZARDS ASSOCIATED WITH ARC WELDING AND PLASMA CUTTING

Arc welding and plasma cutting are processes that can pose hazards for the operator and persons in his vicinity. The operator and his close surroundings are exposed, among others, to the risk of fire, explosion, electric shock, burning, as well as the risk of getting injured by moving parts of the device.

Once proper safety measures are provided, electric welding and plasma cutting are relatively safe processes. For this reason, it is crucial to strictly follow the valid OSH principles during welding operations.

The informations provided below do not release the operator from the obligation to follow the OSH rules that are binding in his plant/workplace.

1.1 GENERAL SAFETY RULES

Welding operators and persons working in the vicinity of the welding process should be made aware of the following hazards associated with arc welding. They should be made aware of protective measures as specified in relevant international and national standards and regulations.

1.1.1 Equipment condition and maintenance

- Check the technical condition of the device and accessories before starting to weld/plasma cutting. It is forbidden to use equipment that is unserviceable.
- Equipment damaged or defective should be immediately repaired or removed from service.

1.1.2 Operation and carrying

- Apply appropriate protective measures in the space around the zone, where welding operations are expected to be carried out.
- All equipment should be placed so that it does not present a hazard in passageways, on ladders or stairways, etc.
- Falling objects can cause injuries or kill. Protect device before accidentally falling.
- Welding equipment may be heavy (e.g. *wire*

feeder fitted with spool and harness). Care shall be taken during manual handling.

- To handle heavy elements, use hoists/trucks/transport equipment designed especially for this purpose. Make sure the weight of equipment to be handled does not exceed the admissible maximum lifting capacity of used hoist/truck/transport equipment.
- It is forbidden for unauthorized persons, especially children, to be in the vicinity of the device during its use.
- The device is not suitable for pipe defrosting.
- Device use non-compliant with its intended purpose is forbidden.

1.1.3 Training

- Only professionally trained and qualified personnel may install, operate, maintain and repair the device.
- For operators and their supervisors training is essential in: the safe use of the equipment; the processes; the emergency procedures.

1.2 ELECTRIC SHOCK CAN KILL



- Before starting to weld and during the welding process, the operator should insulate himself from the ground and the environment by means of dry and undamaged protective clothes. It is forbidden to work on wet ground.
- It is forbidden to touch SK sockets („+“ and/or „-“) when the device is in operation (*connected to a power supply source*).
- It is forbidden to touch live electric components of the device.

- Power supply must never be connected before the accessories of SK sockets/connectors are properly installed in the device.
- Use dry and undamaged welding gloves and protective clothing, in order to ensure proper insulation of the body. It is forbidden to touch with a bare hand any elements that are parts of an electric circuit.
- The operator must always make sure that there is a good electric connection of the return conductor to the element to be welded. The connection should be located as close to the welding zone as possible.
- Maintain the electrode grip, the welding torch, the chassis ground clamp, welding cables and the welding machine in proper technical condition that ensures safe operation. Damaged cable insulation should be replaced with new insulation.
- Never dip an electrode into water, to cool it down.
- When working above the floor level (at a height), use a safety harness to protect yourself against falling, in the case of potential electric shock.
- Exercise special caution, when using the device in small rooms or in rooms with elevated humidity levels.

1.3 WELDING ARC RADIATION CAN BE DANGEROUS

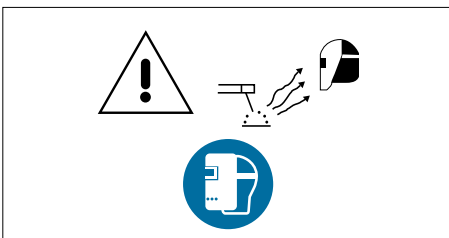

The arc generates:

- ultraviolet radiation (*can damage skin and eyes*);
- visible light (*can dazzle and impair vision*);
- infrared (*heat*) radiation (*can damage skin and eyes*).

Such radiation can be direct or reflected from surfaces such as bright metals and light coloured objects.

1.3.1 Eye and face protection

- Use welder's helmet/shield with an appropriate filter to protect you face and eyes against sparks and welding arc radiation.
- The shield / helmet should provide eye and face protection against injuries that may result in welding spatters.
- Welding helmet/shield should be made in accordance with applicable standards.

1.3.2 Body protection

- The body should be protected by suitable clothing in accordance with applicable standards.
- Use appropriate protective clothing made of durable and fire-resistant material, to ensure proper skin protection.
- The use of neck protection can be necessary against reflected radiation.

1.3.3 Protection of persons in the vicinity of an arc

- Protect the remaining personnel present in the vicinity of welding works against negative impact of arc radiation and welding splatters. Warn them about the hazard resulting from exposure to the welding arc. In the vicinity of an arc, non-reflective curtains or screens should be used to isolate persons from the arc radiation. A warning, e.g. a symbol for eye protection, should refer to the hazard of arc optical radiation. Welder's assistants should also wear appropriate protective clothing.

1.4 VAPOURS AND GASES CAN BE DANGEROUS

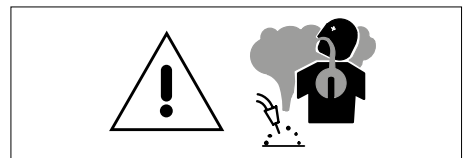

Arc welding and allied processes produce welding fume which may pollute the atmosphere surrounding the work. Welding fume is a varying mixture of airborne gases and fine particles which, if inhaled or swallowed, constitute a health hazard.

The degree of risk is depend on:

- the composition of the fume;
- the concentration of the fume;
- the duration of exposure.

A systematic approach to the assessment of exposure is necessary, taking into account the particular circumstances of the operator and the ancillary worker who can be exposed.

Welding fume may be controlled by a wide range of measures, e.g. process modifications, engineering controls, methods of work, personal protection and administrative action.

First it is necessary to consider whether exposure can be prevented by eliminating the generation of welding fume altogether. Where this cannot be done, measures for reducing the quantity of welding fume generated should be investigated, after which the control of welding fume at source should be considered. The use of respiratory equipment should not be contemplated until all other possibilities have been eliminated. Normally, respiratory protective equipment should be used only as an interim measure. However, there cannot be a situation in which, in addition to ventilation, the use of personal protection is necessary.

1.4.1 VAPOURS AND GASES. ADDITIONAL PRECAUTIONS

- Welding operations can involve generation of vapours and gases that are hazardous to health. Inhaling the vapours should be avoided. Keep your head away from vapours during welding operations. Ensure proper ventilation and/or mechanical welding exhaust draught to keep vapours and gases away from the breathing zone.
- When welding is carried out in a confined space, operators should only be permitted to weld when other persons, who have been instructed and who are able to react

in case of an emergency, are in the immediate vicinity.

- In closed rooms or in certain circumstances during outdoor operations, it may be required to use individual equipment for the protection of the welder's airways, e.g. a respirator. Additional safety measures are also required when galvanized steel is welded.
- Welding operations must not be performed in the vicinity of chlorinated hydrocarbons generated during degreasing, cleaning or spraying. Heat and radiation generated by the arc may enter into a reaction with vapours of solvents, which may lead to the formation of phosgene – a highly toxic gas.
- The shielding gas used during arc welding may force the air out of a room. This may lead to a health hazard or even death. Proper ventilation, especially in closed rooms, should always be provided, to ensure appropriate amount of air that is indispensable for safe breathing.

1.5 NOISE CAN BE HARMFUL



In the welding environment, damaging levels of noise can exist. Continued exposure to a high noise level on the unprotected ear is injurious. The noise levels should be reduced to the lowest practicable level.

High levels may be tolerated for very short periods by wearing adequate ear protection in accordance with the national or local regulation. In case of doubt, checks by an expert should be made to establish noise levels in any particular environment, and, if these are in excess of the prescribed limit, one of the following alternatives may apply:

- a) insulation of the noise source as far as possible, e.g. by fitting silencers or sound proof enclosures,
- b) insulation of the operator from the noise

- source,
- c) effective maintenance of sound protection devices,
- d) indication as „ear protection areas“ where applicable,
- e) restriction of entry to these „ear protection areas“ to authorized persons,
- f) protect your hearing with appropriate personal protection measures, e.g. earplugs or hearing protectors.

1.6 FIRE OR EXPLOSION HAZARD

Arc welding and allied processes can cause fire and explosions. Precautions should be taken to prevent these hazards.

1.6.1 Fire hazard

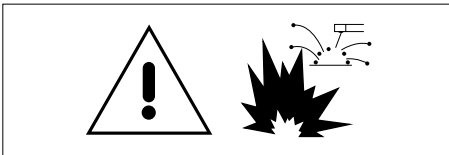

- Before setting to perform welding operations, ensure that elements involving fire hazard are removed from the zone where welding operations will take place. If it is impossible, protect all flammable elements against the impact of sparks. Remember that sparks and hot metal may penetrate through small cracks and openings into the adjacent area.
- Avoid welding in the vicinity of hydraulic conduits.
- The welding arc throws sparks and splatters out. Welders should wear clean and dry protective clothing (*staining with oil should be avoided in particular*) such as welding gloves, welder's apron, welder's trousers, welder's boots, protective hood/cap, etc.
- When welding operations are not carried out, make sure that no part of the electrode comes into contact with the workpiece or protective earthing. Accidental contact may lead to overheating and create a fire hazard.
- The fire extinguisher should be ready for use and located in an easily accessible place.
- The surroundings of the work should be observed for an adequate period after its termination.
- „Hot spots“ and immediate surroundings should be observed until their temperature has dropped to normal.

1.6.2 Explosion hazard

It is forbidden to heat up, cut or weld tanks, barrels or containers that contained toxic or flammable materials. For there is an explosion hazard, even if the containers have been emptied and cleaned.

1.6.3 Use of cylinders with shielding gas

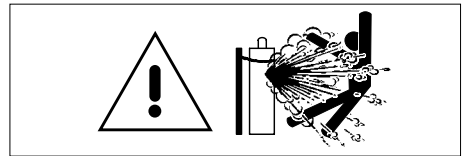

In case compressed gases are used in the work place, apply special safety measures to prevent dangerous situations.

- Use gas cylinders with appropriate shielding gas, foreseen for a particular process. Additional equipment (pressure regulator, hoses, connectors) should be in good technical condition. A gas cylinder and accessories should have the required valid attestations and approvals for use.
- Gas cylinders should always be stored in vertical position, fixed to an undercarriage or permanent support.
- Gas cylinders should be placed far away from areas, where they could be exposed to the risk of being overturned or suffering physical damage.
- Ensure gas cylinders are at a safe distance from places where electric welding or cutting operations are to be performed, away from other sources of heat, sparks or flames.
- Care shall be taken to prevent gas cylinders in the vicinity of the workpiece becoming part of the welding circuit.
- Never allow the electrode, electrode holder or any other live electric part to get in contact with the gas cylinder.
- Keep your face and head away from the

cylinder valve socket when the valve is being opened.

- Special valve shield should always be installed during cylinder transportation or when the cylinder is not used.

1.7 OTHER HAZARDS

Arc welding and allied processes carrying other hazards not listed before.

1.7.1 Burns



- Never touch hot parts with bare hands.
- Before handling an element, wait until it cools down.
- Use appropriate tools to grip and handle hot elements and wear special welding gloves and clothing that protects against burns.

1.7.2 Plasma arc is dangerous

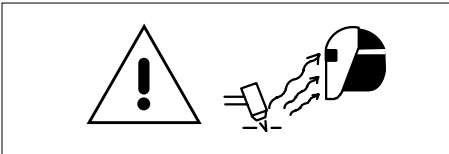

Highly concentrated plasma arc poses a hazard for health and life. It is forbidden to aim plasma arc at people.

1.7.3 Welding wire can cause injuries



Accidental pressing of the button on the welding torch can cause welding wire to advance in an uncontrolled manner. The welding wire tip may be sharp.

Never aim the burner tip of the welding torch at your face, eyes or other people.

1.7.4 Moving elements can be dangerous

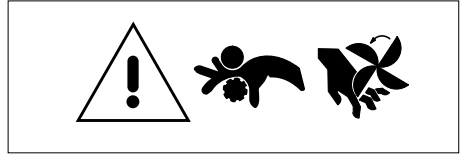

All protective elements and device housing should be in place and in good technical condition. Keep your hands, hair, clothes and tools away from gear wheels, fans and other moving parts during their operation.

Do not bring your hands close to fan motors. It is forbidden to stop a fan by pressing its axis.

1.7.5 HF – high frequency ignition may cause interference



As welding by the TIG method or plasma cutting involves high frequency ignition, it can interfere with mobile phones, radio equipment, TV equipment or improperly protected computers and industrial robots, which leads to total disabling of such devices.

1.8 OTHER INFORMATIONS

When performing welding work, you must apply equally to the health and safety requirements contained in the current normative acts, applicable in your country.

**WARNING!**

The maximum voltage of 15kV. Accidental pressing of the microswitch results in unintentional arc ignition. Never bring a bare hand close to the electrode, when the device is connected to a power source.

1.9 SYMBOLS USED IN INSTRUCTIONS

We use this symbol to pay your attention about important information.

2. ELECTROMAGNETIC FIELDS (EMF)

Electric current flowing through any conductor causes localized electric and magnetic fields (EMF). All welders should use the following procedures in order to minimize the risk associated with exposure to EMF from the welding circuit:

- Route the welding cables together – secure them with tape when possible.
- Place your torso and head as far away as possible from the welding circuit
- Never coil welding cables around your body.
- Do not place your body between welding cables. Keep both welding cables on the same side of your body.
- Connect the return cable to the workpiece as close as possible to the area being welded.
- It is forbidden to sit or lean on power source while working.
- Do not weld whilst carrying the welding power source or wire feeder.

WARNING!

The electromagnetic field (EMF) generated during welding (and allied processes) may interfere with the operation of implanted medical devices for example: cardiac pacemakers. Persons with implanted medical devices such as cardiac pacemakers are obliged to consult a doctor before starting to weld/plasma cutting and to exercise special caution during work. It is forbidden for such persons to be present in the vicinity of the place where welding/plasma cutting processes are realized without previous consultation of a doctor.

3. ELECTROMAGNETIC COMPATIBILITY (EMC)**WARNING!**

This Class A equipment is not intended for use in residential locations where the electrical power is provided by the public low-voltage supply system. There can be potential difficulties in ensuring electromagnetic compatibility in those locations due to conducted as well radiated radio-frequency disturbances.

3.1 GENERAL INFORMATIONS

The user is responsible for installing and using the arc welding equipment according to the manufacturer's instructions. If electromagnetic disturbances are detected, then it shall be the responsibility of the user of the arc welding equipment to resolve the situation with the technical assistance of the manufacturer. In some cases this remedial action may be as simple as earthing the welding circuit. In other cases, it could involve constructing an electromagnetic screen enclosing the welding power source and the work complete with associated input filters. In all cases electromagnetic disturbances shall be reduced to the point where they are no longer troublesome.

Welding and plasma cutting processes may emit additional interferences. User is responsibility for the interferences caused by welding and plasma cutting.

3.2 ASSESMENT OF AREA

Before installing arc welding equipment, the user shall make an assessment of potential electromagnetic interferences in the surrounding area. The following shall be taken into account:

- a) other supply cables, control cables, signaling and telephone cables, above, below and adjacent to the arc welding equipment,
- b) radio and television transmitters and receivers,
- c) computer and other control equipment,
- d) safety critical equipment, for example guarding of industrial equipment,
- e) the health of the people around, for example the use of pacemakers and hearing aids,
- f) equipment used for calibration or measurement,
- g) the immunity of other equipment in the environment. The user shall ensure that other equipment being used in the environment is compatible. This may require additional protection measures.
- h) the time of day that welding or other activities are to be carried out.

The size of the surrounding area to be considered will depend on the structure of the building and other activities that are taking place. The surrounding area may extend beyond the boundaries of the premises.

3.3 METHODS OF REDUCING EMMISIONS

Methods of reducing electromagnetic interference are listed in detail in the standard EN 60974-9 – „Arc welding equipment – Part 9: Installation and use“.

4. CONFORMITY WITH STANDARDS

SPARTUS® EasyMIG 317DP are in conformity with the relevant Union harmonization legislation:

LVD 2014/35/UE	Low Voltage Directive
EMC 2014/30/UE	Electromagnetic Compatibility Directive

harmonized standards:

EN 60974-1	Arc Welding Equipment – Part 1: Welding Power Sources
EN 60974-10	Arc Welding Equipment – Part 10: Electromagnetic Compatibility Requirements

4.1 CE MARKING

CE marking is placed on the nameplate of device and/or on the front panel of device.



4.2 RATING PLATE

Rating plate and serial number are located on the device case.

5. GENERAL DESCRIPTION

SPARTUS® EasyMIG 317DP

It is a modern, inverter welding semi-automatic device produced with using of modern solutions IGBT power transistors. It allows: **MIG/MAG synergy welding with double pulse, MIG/MAG synergy welding with pulse, MIG/MAG synergy welding, MIG/MAG welding in manual**

setting mode, TIG Lift welding, MMA coated electrode welding. In addition, the device, thanks to the possibility of changing the welding polarity, allows welding with self-shielding wire without gas. The maximum welding current for the MIG/MAG/TIG methods is 300A, and 250A in MMA method. The machine is powered with a three-phase 400V source power.

EasyMIG 317DP enables wire work in terms of 0.8 - 1.2mm diameters. The device equipped with synergic programs also allows you to introduce manual corrections of the set parameters. Pulsed current welding is an additional advantage of the device. MIG/MAG double pulse welding enables to obtain a weld of a quality and aesthetics comparable to the TIG method.

Benefits of using MIG/MAG double pulsation:

- high aesthetics (husk effect),
- higher welding efficiency compared to the TIG method,
- smaller thermal deformations compared to the TIG method,
- when welding aluminum requires less skill from the operator in relation to the TIG method.

For easier and more effective work EasyMIG 317DP is equipped with functions supporting the welding process, such as:

- **2T/4T** – choice of one of two operating modes (MIG/MAG),
- **Inductance** – regulation of welding inductance – control of the width of the weld face and the depth of penetration (MIG/MAG), reduce the amount of welding splashes,
- **Spool Gun** – light and durable welding gun, with a built-in wire feeder and a spool in the handle (MIG/MAG),
- **Hot Start** – easier electrode ignition (MMA),
- **Arc Force** – more convenient welding in forced positions (MMA),
- **VRD** – voltage reduction (MMA).

Built-in four-roll feeder ensures stable welding wire feeding. SPARTUS® EasyMIG 317DP is a handy welding machine and is ideal for both industrial plants and workshops.

5.1 PURPOSE OF USE

SPARTUS® EasyMIG 317DP welding machine is designed for:

- Metal Inert Gas welding (MIG) or Metal Active Gas welding (MAG),
- Tungsten Inert Gas welding (TIG),
- Manual Metal Arc welding (MMA).

6. TECHNICAL SPECIFICATIONS

6.1 OPERATION, STORAGE AND TRANSPORT

Conditions during operation, storage and transport

Range of ambient air temperature during operation	-10°C to +40°C
Relative humidity of the air	up to 50% at +40°C up to 90% at +20°C
Ambient air	free from abnormal amounts of dust, acids, corrosive substances etc. other than those generated by the welding process

Base of the welding power source inclined	no more than 10°
Range of ambient air temperature during storage and transport	-20°C to +55°C
Height above sea level	≤1000 m

**Duty cycle (def.)**

Duty cycle is the time during which You can weld or cut at a certain load without causing overload. It is expressed in percent for period of complete cycle which equals 10 minutes. For example: 60% duty cycle means that for 6 minutes device can operate at given load, after that required 4 minutes time break (no-load operation).

**Protection against overheating (def.)**

Security system from overheating will turn on when the welder is over-heat (possibility of welding is turned off, abnormal indicator on front panel lights up). In such a situation, You should not turning off the unit immediately. Wait some time until fan cools the unit. Time to return to the state from overheating can take up to approx. 15 minutes.



The device has a degree of protection IP21S. Which means that it is intended to be used in closed and covered areas and suitable for use outdoors. However it is not designed to be used outdoor during precipitation if it is not covered.

6.2 TECHNICAL PARAMETERS OF DEVICE

EasyMIG 317DP

Input	~3 × 400V ± 10% 50 / 60 Hz
Welding current MIG [A]	50 – 300
Duty cycle MIG [%]	60

MIG PARAMETERS

Output working voltage [V]	16.5 – 29.0
Wire feeder	built-in, 4-roll gear
Wire diameter Ø [mm]	0.8 / 1.0 / 1.2
Welding wire spool	≤ 15[kg], ø200/300
Inductance control	✓
Wire feeding test	✓
2T / 4T control	✓
Synergic	✓ Easy
Welding polarity change	✓
Spool Gun	✓

TIG PARAMETERS

TIG welding mode	Tig DC Lift
TIG welding current [A]	10 – 300
Duty cycle [%]	60

MMA PARAMETERS

MMA welding mode	✓
MMA welding current [A]	10 – 250
Duty cycle [%]	60
Hot Start	0 – 10
Arc Force	0 – 10
VRD	✓

OTHER

Max. current consumpition [A]	MIG 25 / TIG 20 / MMA 21
Efficiency η [%]	MIG 84.5 / TIG 84 / MMA 85.5
No load voltage (V)	78
Power factor ($\cos\phi$)	0.6
Insulation class	H
Protection class	IP21S
Weight [kg]	22.5
Dimensions [mm]	570 x 265 x 460

7. INSTALLATION AND USE



WARNING!

*SPARTUS® EasyMIG machines are intended for professional and industrial applications. Installation and use of the device may only be carried out appropriately trained professionals. It is **forbidden** to grinding and/or carrying out other locksmith works or mechanical working of metal in the vicinity of the ventilation opening of unit.*



Qualified person (def.)

A person who has gained the relevant technical education, training took place and / or gained experience to perceive the risk and avoid hazards during use of the product (IEC 60204-1).

7.1 PROPER COOLING

The unit should be placed stable on a dry and flat surface. Avoid too much slope and slippery surfaces. Check regularly that the vents (inlet, outlet) are not covered. The minimum distance between the welder vents and walls should be 50cm.

7.2 MOVEMENT AND HANDLING

When moving the welding machine please take special care. The device should be moved by using specially designed transport lugs. If transport handle is damaged, then it needs to be repaired at an authorized service center.

7.3 DESCRIPTION OF CONSTRUCTION

7.3.1 Welding source

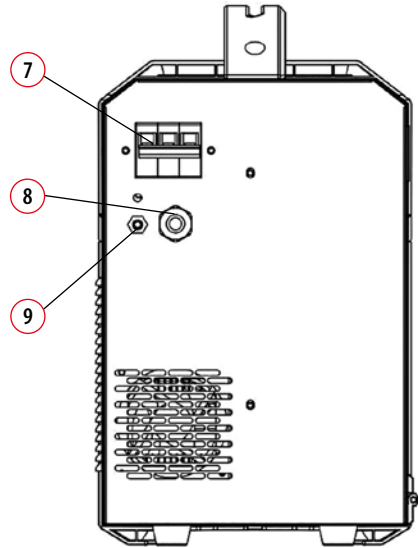
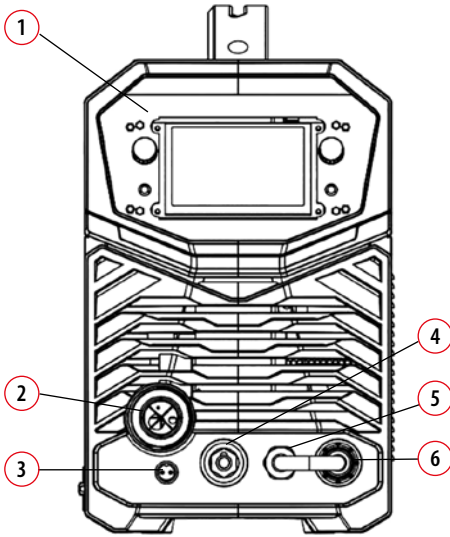

- ① Control panel
- ② EURO socket – MIG gun connector
- ③ SPOOL GUN connection socket
- ④ SK_{„+“} socket
- ⑤ Cable to determine the polarity of the EURO socket

- ⑥ SK_{„-“} socket
- ⑦ Toggle switch ON/OFF
- ⑧ Power cable
- ⑨ Gas cylinder socket

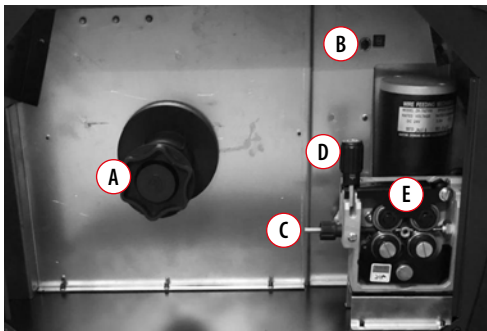

- Ⓐ Clamping mechanism welding wire with nut
- Ⓑ Wire check button
- Ⓒ Wire inlet guide
- Ⓓ Tension adjustment knob
- Ⓔ Tensioner arm

7.4 CONNECTING TO POWER SUPPLY

Requirements for power network parameters (voltage, permissible range of mains voltage fluctuations etc.) are given in the table with technical parameters of device and on the rating plate of welding machine.

Before connecting the unit to the power source:

- Check whether the parameters comply with the requirements for unit.
- Check: mechanical condition of the power cord and plug. The connection status of the power cord with plug and unit (loose not allowed). If the power cord or plug is damaged or loose connection is between them, it is forbidden to connect the welder until fault has been rectified.
- The welder machine can be connected to the network only when the power socket is properly grounded.

7.5 INSTALLATION – MIG/MAG WELDING



Before installation the welding wire spool, make sure that weight and dimension of the spool meet the requirements set out in the table with technical data of device.



Before connecting hardware and shielding gas to the device, make sure that the device is disconnected from power source and switch **7** is in the OFF position.

7.5.1 Connecting the gas cylinder

1. The cylinder with appropriate shielding gas, should be placed in a vertical position and secured against falling over in accordance with safety requirements (*for gas cylinders under the influence*).
2. Make sure that the valve cylinder is closed.
3. Connect properly gas regulator to cylinder valve.
4. Connect the gas hose into gas regulator outlet. Secure the connection with a special clamp.
5. Connect the gas hose to the device **9**.



The valve in the cylinder must be opened immediately before welding. After welding it should be closed.

7.5.2 Welding wire spool installation

1. Unlock the mounting block in the mounting bracket.
2. Place the wire spool on mounting mechanism. Pay attention to direction of unwinding welding wire (basic criterion – minimum bending radius of wire, linearly to wire inlet guide **C**). Locking pin should be placed in special hole in wire spool.
3. Lock the mounting block in the mounting bracket.
4. Unlock tension knob **D**. Check if the feed rolls are proper to type and diameter of welding wire.
5. Pass end of wire through wire inlet guide **C**, through groove of drive roll and EURO socket guide. The end of welding wire should leave a distance approx. 10mm beyond outline of EURO socket **2**.
6. Lock tension knob **D**.

7.5.3 MIG/MAG gun installation

1. Connect properly MIG gun plug to EURO socket (2).
2. Pay special attention to the correct fit of the control pins and input welding wire from wire feeder to the wire inlet guide in MIG gun.
3. Tighten the MIG gun plug nut clockwise until it stops. Incorrectly mounted MIG gun can cause damage.



7.5.4 Assembling welding wire into liner

1. Connect properly MIG gun into welding machine (see 7.5.3).
2. Dismantle the torch consumables (gas nozzle, contact tip).
3. Connect the welder into power supply. Turn on the machine using power switch (7).
4. Expand MIG gun as straight as it is possible.
5. Start wire feeding into MIG gun liner. Make sure that pressure tension of feeder rolls is suitable. Remember! Never point torch into direction eyes / face or others.
6. Wire end should come out to a distance approx. 30mm beyond the torch outline.
7. Assemble welding wire into liner (gas nozzle, contact tip).
8. Cut off the end of wire properly.

7.5.5 Device installation – MIG/MAG welding



Before connecting hardware and shielding gas to the device, make sure that the device is disconnected from power source and switch (7) is in the OFF position.



For most applications during MIG/MAG welding the polarity of the welding should be positive, '+' on the EURO socket and negative, '-' on the return cable.

7.5.5.1 Setup for gasless welding

1. Connect the MIG torch to the machine (see 7.5.3).
2. Check that the correct flux cored, gasless wire, matching drive roller and welding tip are fitted.
3. Connect torch power lead to the negative welding output terminal SK, '-' (6).
4. Connect earth lead connector to the positive output welding terminal SK, '+' (4), and earth clamp to the workpiece.

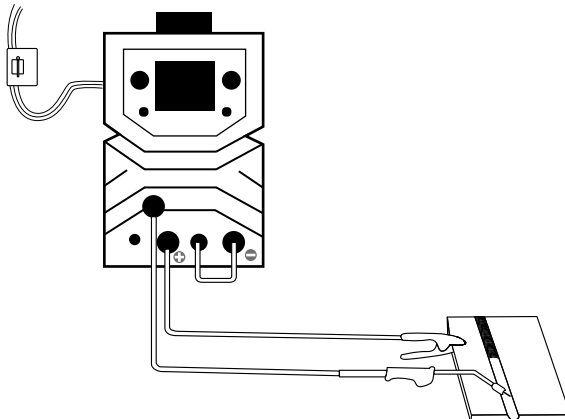

7.5.5.2 Setup for gas shielded welding

1. Connect the gas hose to the machine (9).
2. Connect MIG/MAG gun to the machine (see 7.5.3).
3. Make sure that all threaded connections are not loose and that the shielding gas connection is tight.
4. Connect cable to determine the polarity of gun to socket SK „+“ (4).
5. Connect return cable into SK socket „-“ (6) and the mass clamp to the welded part.
6. Connect the machine to the power supply in accordance with appropriate guidelines (see 7.4).
7. Turn on the device by setting the switch (7) to ON position.
8. Insert the welding wire to the handle (see 7.5.4).
9. Unscrew the valve in the gas cylinder and set the appropriate value for the shielding gas flow. By using the „GAS“ (gas test) button on the front function panel.
10. The machine is ready for welding.

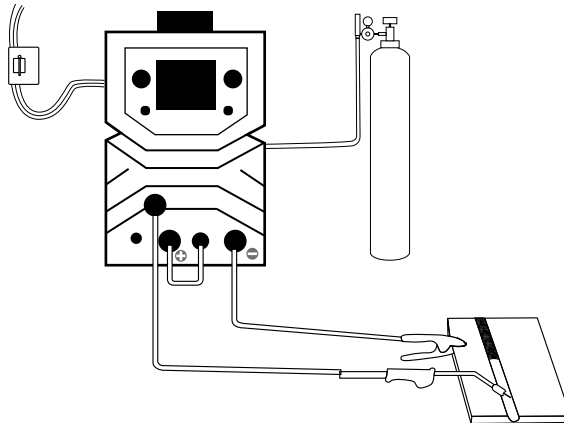

7.5.5.3 Setup for welding with SPOOL GUN

1. Connect the gas hose to the machine (9).
2. Connect the SPOOL GUN to the EURO socket (2) and switch plug to the aviation socket (3).
3. Make sure that all threaded connections are not loose and that the shielding gas connection is tight.
4. Connect polar conversion line into SK socket „+“ (4).
5. Connect earth lead quick connector into SK socket „-“ (6) and the earth clamp to the work piece.
6. Connect the machine to the power supply in accordance with appropriate guidelines (see 7.4).
7. Turn on the device by setting the switch (7) to ON position.
8. Insert the welding wire to the handle (see 7.5.4).
9. Unscrew the valve in the gas cylinder and set the appropriate value for the shielding gas flow.
10. The machine is ready for welding..

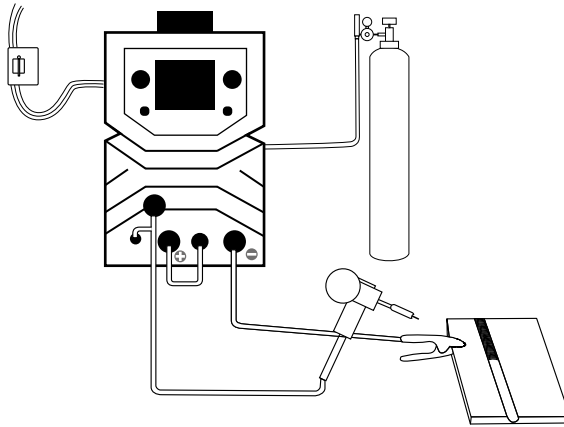

7.6 INSTALLATION – MMA WELDING



Before connecting hardware and shielding gas to the device, make sure that the device is disconnected from power source and switch (7) is in the OFF position.



The welding polarity depends on the type of electrodes used. Before connecting the cables refer to the requirements specified by the manufacturer of electrodes.

1. Connect electrode cable plug into SK socket „+“ (4).
2. Connect return cable plug into appropriate SK socket „-“ (6).
3. Connect earth clamp into workpiece.
4. Connect the welder into power supply in accordance with appropriate guidelines (see 7.4).
5. Turn on the welder by setting power switch (7) in the ON position.
6. The device is ready to weld.

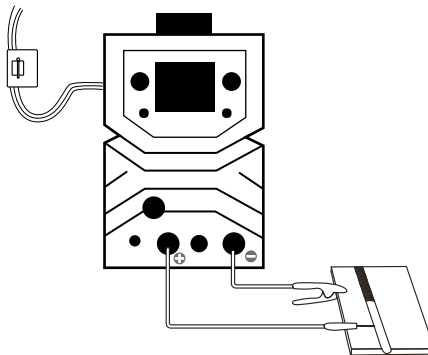

7.7 INSTALLATION – TIG WELDING



Before connecting hardware and shielding gas to the device, make sure that the device is disconnected from power source and switch **7** is in the OFF position.

7.7.1 Connecting the gas cylinder

1. The cylinder with appropriate shielding gas, should stand upright and be secured against tipping over in accordance with safety requirements.
2. Make sure that the valve cylinder is closed.
3. Connect properly gas regulator to cylinder valve.
4. Connect the gas hose into gas regulator outlet. Use special clamps to seal connection.
5. Connect gas hose to the TIG torch with valve.

7.7.2 TIG torch installation

1. Connect TIG torch current plug to the SK_{,-} socket **6**.
2. Connect the gas hose to the TIG torch.
3. Connect earth lead connector to the positive output welding terminal SK_{,+} **4**, and earth clamp to the workpiece.
4. Turn on the device by setting the switch **7** to ON position.
5. The machine is ready for welding.

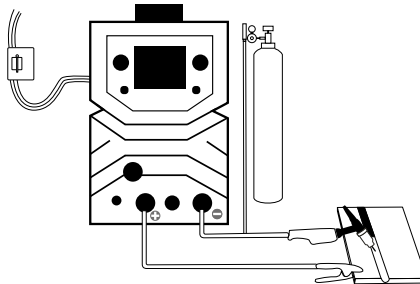

MIG parameter

MATERIAL	WIRE DIAMETER [mm]	PROCESS	SHIELDING GAS
Carbon steel	0.8 / 1.0 / 1.2	MIG (constant voltage)	100%CO ₂
Carbon steel	0.8 / 1.0 / 1.2	MIG (constant voltage)	75%Ar + 25%CO ₂ mixed gas
Carbon steel	0.8 / 1.0 / 1.2	Single/ Double Pulse	80%Ar+20% CO ₂ mixed gas
Stainless steel	0.8 / 1.0 / 1.2	Single/ Double Pulse	80/20 mixed gas
Stainless steel	0.8 / 1.0 / 1.2	Single/ Double Pulse	97.5/2.5 mixed gas
AlSi	1.0 / 1.2	Single/ Double Pulse	100% argon
AlMg	1.0 / 1.2	Single/ Double Pulse	100% argon
CUSi	0.8 / 1.0 / 1.2	Single/ Double Pulse	100% argon

7.8 DEVICE CONTROL PANEL – USING

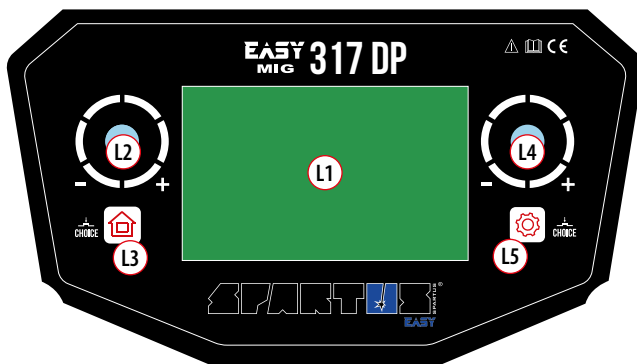

- L1** LCD display
- L2** Welding mode selection/MIG voltage refine knob
- L3** Home button
- L4** Parameters adjust knob
- L5** Selection parameter button: wire speed / wire diameter / inductance / 2-4T mode / Hot Start / Arc Force

Description of parameters on the LCD display



- G1** Welding current
- G2** Wire feed speed
- G3** Welding voltage
- G4** Fine adjustment of welding voltage – shape of the front of the weld
- G5** Welding material & gas
- G6** Inductance
- G7** Slow Feed
- G8** Wire diameter
- G9** 2T/4T operating modes
- G10** Gas post-flow
- G11** Plate thickness

FUNCTIONAL INTERFACE – MIG DC

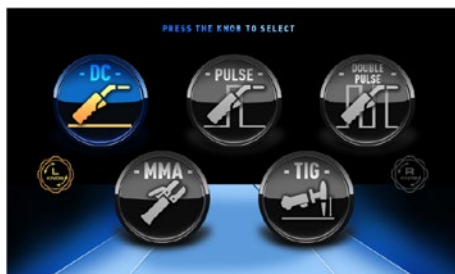

1. Wait 5 seconds, after turning on the machine, for the digital control program to load up.
2. Press the left button (L3) to mode selection, and select the mode by left knob (L2) and press the knob to confirm the selection.



3. The values of welding voltage and wire feeding speed are adjusted by rotating the right knob (L4). Because of the synergic digital programming, both the voltage and the wire speed will adjust together. The welding voltage is regulated independently by turning the left knob.
4. Press the right button (L5) to adjust the wire diameter, welding mode, post gas and slow feed. Use right knob (L4) to set the appropriate parameters.

5. **Inductance adjustment** – press the right button (L5) and use right knob (L4) to adjust the inductance from -10 to +10 (*Inductance effectively adjusts the intensity of the welding arc. inductance makes the arc 'softer', with less weld spatter. Higher inductance gives a stronger driving arc which can increase penetration. Optimum inductance settings are affected by many welding variables such as: material type, shielding gas joint type, welding amperage, wire size, welding amperage, wire size*).
6. **2T/4T function** – press the right button (L5) to select 2T or 4T mode. 4T operation means the trigger is pulled once to start welding and pulled again to stop. This is useful for long weld joints. 2T mode, the trigger must be depressed and held during welding.
7. **Post flow time** – press the right button (L5) to adjust the post-flow time. Turn the right knob (L4) to adjust post gas.
8. **Slow wire-feeding** – press the right button (L5) and turn the right knob (L4) to adjust the slow wire-feeding.

FUNCTIONAL INTERFACE – MIG Pulse / Dual Pulse



Press the left button (L3) to mode section and select PULSE or DOUBLE PULSE mode by left knob (L2). Press the knob to confirm the selection.



The parameters of voltage, welding current and current, inductance, wire diameter, 2T/4T mode are set in the same way as in MIG DC.



Single pulse frequency is automatically matched and adjusted (pulse frequency is proportional to current). When the wire feeding speed is less than 2.5m/min in single pulse mode, welder will enter COOL PULSE mode automatically. Welding material use in single pulse mode is suitable for cold pulse welding (COOL PULSE welding only appear under the single pulse mode).

(Pulse frequency, Pulse width, base current only available for DOUBLE PULSE mode).



- Pulse width (from 20% to 80%)
- Base current (from 20A to 99A)

Pulse frequency (from 1.0Hz to 2.5Hz)

Pulse frequency, Pulse width and **base current** should be set using the right knob (L4) – press it, turn the knob to set appropriate parameter and press it again to save. (*Pulse width is to adjust the duration of pulse welding current. The wider the pulse width, the weld bead is wide and deep.*)

FUNCTIONAL INTERFACE – MMA

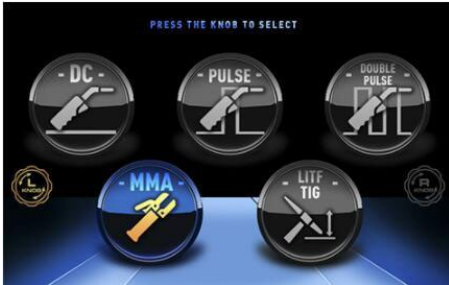

1. Press the left button (L3) to mode selection, and select the MMA mode by left knob (L2) and press the knob to confirm the selection.



2. The screen will show the preset MMA welding current. This can be adjusted by rotating the right knob (L4).
3. Press the right button (L5) to adjust Hot Start and Arc Force. Use right knob (L4) to set the appropriate parameters 0-10.

4. VRD is a safety system that reduces this open circuit voltage to a level where the risk of electric shock is minimized. It does, however, make striking of the arc more difficult. Press the right button (L5) to switch VRD on/off..

FUNCTIONAL INTERFACE – TIG Lift



1. Press the left button (L3) to mode selection, and select the TIG LIFT mode by left knob (L2) and press the knob to confirm the selection.



- The screen will show the preset TIG Lift welding current. During welding, the display will show the actual welding voltage and current. This can be adjusted by rotating the right knob (L4).

WARNINGS AND ACTION



OVER TEMPERATURE!

When machine operates at full load maximum current for a long time, a OVER TEMPERATURE will appear. This means that the temperature inside the machine has exceeded the standard temperature. Please stop welding immediately, but do not turn off the power and let the fan continue to operate and let the welder cooling. Welding can be resumed after the welding temperature drops below the standard temperature and there is no warning display of OVER TEMPERATURE.



OVER CURRENT!

When the IGBT current exceeds the safety value when the welding machine is running, the welding machine will enter the OVER CURRENT protection to prevent the damage of IGBT. Please stop welding immediately, turn off the welder for 10-30s and then restart it. If the OVER CURRENT warning still appear, need to be repaired by professional maintenance personnel.

8. MAINTENANCE



WARNING!

Before performing any maintenance or repairing of device, disconnect welding machine from the power source and wait at least 5 minutes. The voltage accumulated in capacitors should be discharged at this time to a safe level. But even after that operation you should be careful.



*Make sure that the device is disconnected from the power source, and switch **7** is in the OFF position, before connecting accessories and shielding gas to the device.*

Maintenance and repair work may be performed only by qualified personnel with the appropriate permissions. Regular maintenance provides adequate service life and trouble-free operation of the device.

Routine maintenance (daily: before use/installation):

- Perform a visual inspection of the housing, knobs, control panel.
- Inspect (visual inspection) the power cord and power plug. Check the insulation of the cable.
- Check the condition of welding cables and their connectors. If cable insulation is damaged – replace it. If connection is too loose – eliminate backlash.
- Check if cooling fan is working properly.
- Make sure that all vents are not obstructed.

At least once a month:

- Regularly remove dust from inside of the machine. Use for this compressed air. The pressure should be sufficiently low so as not to damage small components inside the machine. If in the workplace, dust levels are high. You should clean machine often.
- Perform inspection of connection of internal electrical components. If anywhere the joints are loose, tighten them.

Once a year:

- You should send device to an authorized service center for an interim review.

9. ENVIRONMENTAL PROTECTION

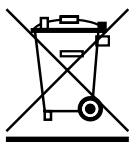

The product must not be disposed of into an ordinary waste container. It is totally forbidden to dispose of electric or electronic equipment marked with a crossed-out trash can symbol by throwing it into ordinary waste containers. According to the WEEE directive (directive 2012/19/UE), binding within the European Union, such products should be disposed of according to local regulations.

We hereby inform the client that, according to the regulations, each commodity is burdened with waste disposal costs (WDC) according to charging rates valid for a given year.

Attention! If using liquid to water-cooled torches, utilize it according to attached information.

10. TROUBLESHOOTING



Not all problems with functioning of the device, are the evidence of failure. You can independently carry out an analysis in search of probable failure. In case of doubt, please contact to SPARTUS® dealer or authorized service center.



During the warranty period all repairs should be carried by authorized service center. Repairs carried out by unauthorized persons will void the warranty.

<i>PROBLEMS WITH THE DEVICE</i>	
After turning ON the switch the device does not respond.	Poorly connected to the supply voltage. Failure of power switch.
No arc.	No power supply. A break in circuit welding. A break in the control circuit.
Overheat protection is on.	Excessive welding current. Exceeded duty cycle.
<i>MIG WELDING PROBLEMS</i>	
Excessive heating of MIG gun.	Contact tip is not properly fastened or tightened. Too high welding current in relation into MIG gun capacity.
Unstable wire feeding.	Blocked guide wire (liner). Worn contact tip. Contact tip diameter is not suitable to wire diameter. Wrong adjustment of tension pressure of rolls.
Unstable arc welding.	Contact tip is worn or its diameter is incorrect. Incorrect welding parameters. Worn liner.
Inadequate or missing gas cover.	Closed valve in the gas cylinder. Closed valve in the gas pressure regulator. The gas hose clamps are not tightened. Torch gas hose blocked or damaged. Shielding gas flow rate too low. Clogged gas hoses leading the gas to the device.
<i>MMA WELDING PROBLEMS</i>	
Unstable arc welding, excessive spatter welding, poor weld quality.	Incorrect welding polarity. Electrode is damp or incorrectly heated. Unstable voltage in. Parameter display damaged, incorrect display indications.
<i>TIG WELDING PROBLEMS</i>	
The problem of obtaining adequate weld penetration.	Too low welding current.
Poor quality of weld.	Improper welding parameters. Too little flow of the shielding gas or its quality is inadequate. Excessively worn of tungsten electrode.



EASY

Simple solutions and an attractive price – these are the features of SPARTUS® Easy series devices. Our equipment has been designed with ease of use and ergonomics at work in mind.

A masterly combination of high quality production, excellent parameters and ergonomics – these are features of the SPARTUS® Master series of devices, which were created with demanding welding jobs in mind.



MASTER

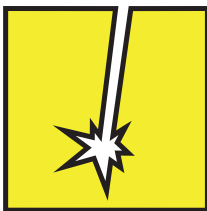

PRO

Precision, functionality, excellent parameters and resistance to high workloads – these are the features of the SPARTUS® Pro industrial series of devices. This series consists of specialised solutions which will satisfy even the most demanding users.



Videopresentation of products



Subscribe to the channel [SPARTUS.INFO](https://www.youtube.com/channel/UC...)